

Damper actuator for adjusting air dampers in ventilation and air-conditioning systems for building services installations

- For air dampers up to approx. 4 m²
- Torque 20 Nm
- Nominal voltage AC 100 ... 240 V
- Control: Open-close or 3-point
- with integrated auxiliary switch
- with connecting terminals

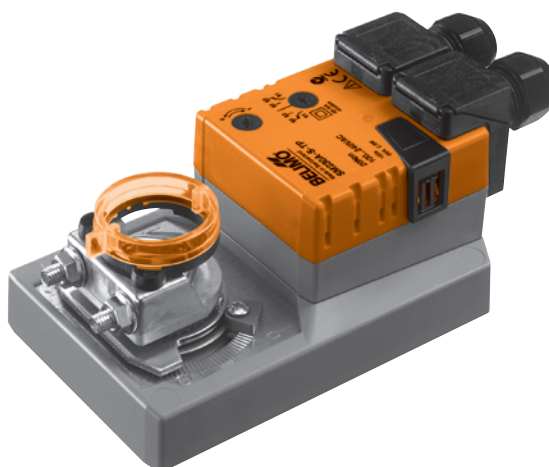

Technical data

Electrical data	Nominal voltage	AC 100 ... 240 V, 50 / 60 Hz	
	Nominal voltage range	AC 85 ... 265 V	
	Power consumption	In operation	2.5 W @ nominal torque
		At rest	0.6 W
		For wire sizing	6 VA
	Auxiliary switch	1 x SPDT, 1 mA ... 3 (0.5) A, AC 250 V <input type="checkbox"/>	(0 ... 100% adjustable)
Connection	Motor	Terminals 4 mm ² (Cable Ø 4 ... 10 mm, 3-core)	
	Auxiliary switch	Terminals 4 mm ² (Cable Ø 4 ... 10 mm, 3-core)	
Functional data	Torque (nominal torque)	Min. 20 Nm @ nominal voltage	
	Direction of rotation	Reversible with switch 0 ↺ resp. 1 ↻	
	Manual override	Gearing latch disengaged with pushbutton, can be locked	
	Angle of rotation	Max. 95° ↺, can be limited at both ends with adjustable mechanical end stops	
	Running time	150 s / 90° ↺	
	Sound power level	Max. 45 dB (A)	
	Position indication	Mechanical, pluggable	
	Safety	Protection class	II Totally insulated <input type="checkbox"/>
Degree of protection		IP54 in any mounting position NEMA 2, UL Enclosure Type 2	
EMC		CE according to 2004/108/EC	
Low voltage directive		CE according to 2006/95/EC	
Certification		cULus according to UL 60730-1A and UL 60730-2-14 and CAN/CSA E60730-1:02 Certified to IEC/EN 60730-1 and IEC/EN 60730-2-14	
Mode of operation		Type 1	
Rated impulse voltage		2.5 kV	
Control pollution degree		3	
Ambient temperature range		-30 ... +50 °C	
Non-operating temperature		-40 ... +80 °C	
Ambient humidity range	95% r.h., non-condensating		
Maintenance	Maintenance-free		
Dimensions / Weight	Dimensions	See «Dimensions» on page 2	
	Weight	Approx. 1.1 kg	

Safety notes



- The actuator is not allowed to be used outside the specified field of application, especially in aircraft or any other form of air transport.
- **Caution: Power supply voltage!**
- **Assembly must be carried out by trained personnel. Any legal regulations or regulations issued by authorities must be observed during assembly.**
- The device may only be opened at the manufacturer's site. It does not contain any parts that can be replaced or repaired by the user.
- When calculating the required torque, the specifications supplied by the damper manufacturers (cross section, design, installation site), and the air flow conditions must be observed.

Safety notes

(Continued)

- The device contains electrical and electronic components and is not allowed to be disposed of as household refuse. All locally valid regulations and requirements must be observed.

Product features

- Simple direct mounting** Simple direct mounting on the damper spindle with a universal spindle clamp, supplied with an anti-rotation strap to prevent the actuator from rotating.
- Manual override** Manual override with push-button possible (the gear is disengaged for as long as the button is pressed or remains locked).
- Adjustable angle of rotation** Adjustable angle of rotation with mechanical end stops.
- High functional reliability** The actuator is overload-proof, requires no limit switches and automatically stops when the end stop is reached.
- Flexible signalization** Flexible signalization with adjustable auxiliary switch (0 ... 100%).

Accessories

	Description	Data sheet
Electrical accessories	Auxiliary switch S..A..	T2 - S..A..
	Feedback potentiometer P..A..	T2 - P..A..
Mechanical accessories	Various accessories (clamps, shaft extensions etc.)	T2 - Z-SM..A..

Electrical installation

Wiring diagrams

Notes

- Caution: Power supply voltage!
- Other actuators can be connected in parallel. Please note the performance data.



Direction of rotation



Auxiliary switch



Open-close control

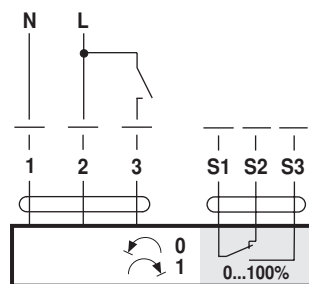

3-point control

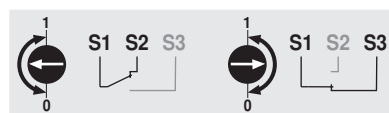
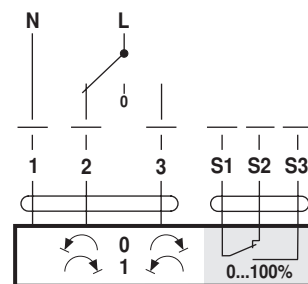

Dimensions [mm]

Dimensional drawings

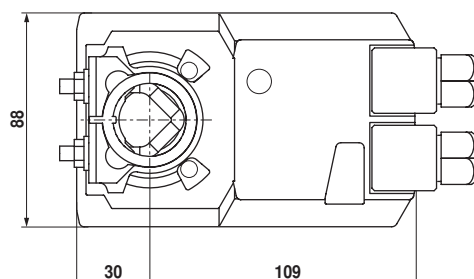
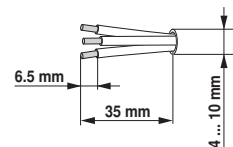
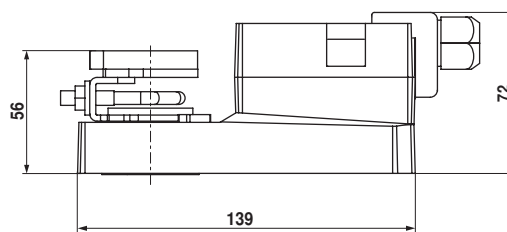



Damper spindle	Length	● I	■ I	◆ I
	≥48	10 ... 20 ¹⁾	≥10	≤20
	≥20	10 ... 20 ¹⁾	≥10	≤20

¹⁾ CrNi (INOX) 12 ... 20

70214-00003.D

1

			
	10 ... 20	≥10	≤20
CrNi (INOX)	12 ... 20	≥10	≤20

2

3

4

9 Nm
CrNi (INOX) 15 Nm

1 mm

5

Z-PI

65°

≥20

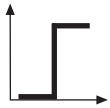
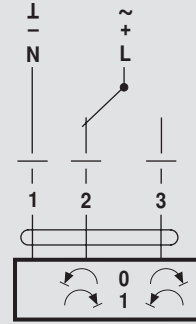
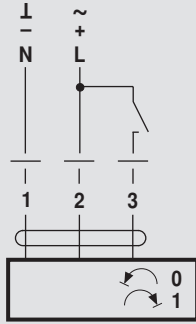

AC 24 V / DC 24 V

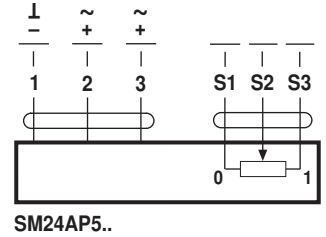
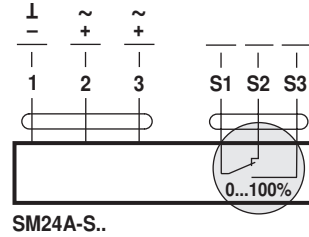
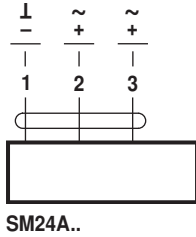

AC 100 ... 240 V ⚠

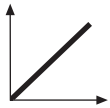
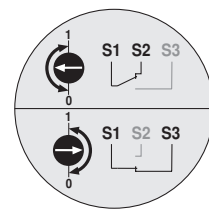
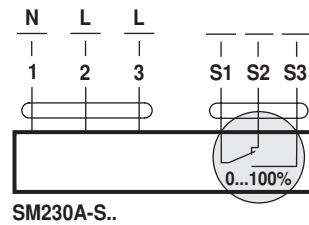
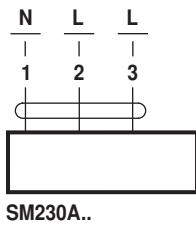

AC 24 V / DC 24 V

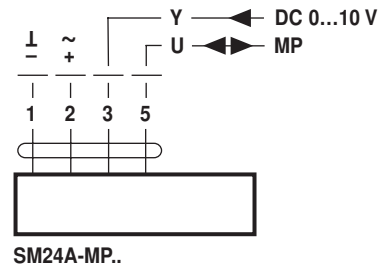
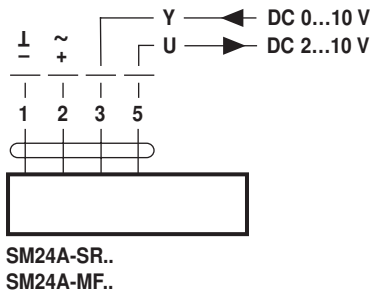

AC 100 ... 240 V ⚠

