

Rotary actuator with emergency function for 2- and 3-way ball valves

- Torque 10 Nm
- Nominal voltage AC/DC 24 V
- Control: Open-close
- Two integrated auxiliary switches
- NRF24A-S2: Deenergised NC
- NRF24A-S2-O: Deenergised NO

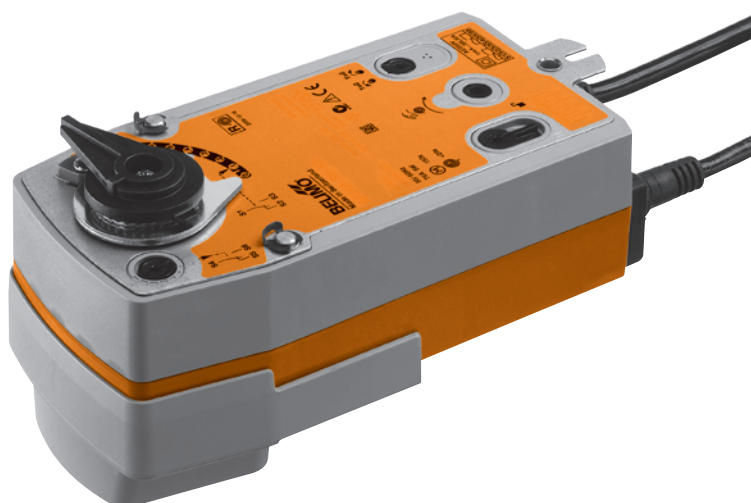

Technical data

Electrical data	Nominal voltage	AC 24 V, 50/60 Hz / DC 24 V	
	Nominal voltage range	AC 19.2 ... 28.8 V / DC 21.6 ... 28.8 V	
	Power consumption	In operation	6 W @ nominal torque
		At rest	2.5 W
		For wire sizing	8.5 VA
	Auxiliary switch	2 x SPDT, 1 mA ... 3 (0.5) A, AC 250 V <input type="checkbox"/> (1 x fix 10% / 1 x adjustable 11 ... 100%)	
	Connection	Motor	Cable 1 m, 2 x 0.75 mm ²
Auxiliary switch		Cable 1 m, 6 x 0.75 mm ²	
Parallel connection	Yes (Note performance data for supply!)		
Functional data	Torque	Motor	Min. 10 Nm @ nominal voltage
		Spring return	Min. 10 Nm
	Direction of rotation	Spring return	
		– NRF24A-S2 – NRF24A-S2-O	Deenergised NC, ball valve closed (A – AB = 0%) Deenergised NO, ball valve open (A – AB = 100%)
	Manual override	With hand crank and interlocking switch	
	Angle of rotation	Max. 90° $\overleftarrow{\rightleftarrows}$	
	Running time	Motor	≤75 s / 90° $\overleftarrow{\rightleftarrows}$
		Spring return	≤20 s @ –20 ... 50°C / max. 60 s @ –30°C
	Sound power level	Motor	≤45 dB (A)
		Spring return	≤62 dB (A)
Position indication	Mechanical		
Safety	Protection class	III Extra low voltage / UL Class 2 Supply	
	Degree of protection	IP54	
		NEMA 2, UL Enclosure Type 2	
	EMC	CE according to 2004/108/EC	
	Low-voltage directive	CE according to 2006/95/EC	
	Certification	cULus according to UL 60730-1A and UL 60730-2-14 and CAN/CSA E60730-1:02	
		Certified to IEC/EN 60730-1 and IEC/EN 60730-2-14	
		Type 1.AA.B	
	Mode of operation	Type 1.AA.B	
	Rated impulse voltage	Actuator	0.8 kV
		Auxiliary switch	2.5 kV
	Control pollution degree	3	
	Ambient temperature	–30 ... +50°C	
Media temperature	+5 ... +100°C (in ball valve)		
	–10°C with stem heating upon request		
Non-operating temperature	–40 ... +80°C		
Ambient humidity	95% r.h., non-condensating		
Maintenance	Maintenance-free		
Dimensions / Weight	Dimensions	See «Dimensions» on page 3	
	Weight	Approx. 2.2 kg (without ball valve)	

Safety notes



- The actuator has been designed for use in stationary heating, ventilation and air conditioning systems and is not allowed to be used outside the specified field of application, especially in aircraft or in any other airborne means of transport.
- It may only be installed by suitably trained personnel. All applicable legal or institutional installation regulations must be complied with.
- The device may only be opened at the manufacturer's site. It does not contain any parts that can be replaced or repaired by the user.
- The cable must not be removed from the device.
- The device contains electrical and electronic components and is not allowed to be disposed of as household refuse. All locally valid regulations and requirements must be observed.

Product features

Mode of operation	The actuator moves the ball valve to the operating position at the same time as tensioning the return spring. The ball valve is turned back to the safety position by spring force if the supply voltage is interrupted.
Simple direct mounting	Straightforward direct mounting on the ball valve with only one screw. The mounting position in relation to the ball valve can be selected in 90°-steps.
Manual override	Manual operation of the valve with the hand crank, locking in any position with the interlocking switch. Unlocking is manual or automatic by applying the operating voltage.
Adjustable angle of rotation	Adjustable angle of rotation with mechanical end stop.
High operational reliability	The actuator is overload-proof, requires no limit switches and automatically stops when the end stop is reached.
Flexible signalization	The actuator has one auxiliary switch with a fixed setting and one adjustable auxiliary switch. They permit a 10% or 11 ... 100% angle of rotation to be signalled.
Combination valve actuators	Refer to the valve documentation for suitable valves, their permitted media temperatures and closing pressures.

Electrical installation

Wiring diagram

Notes

- Connect via safety isolation transformer.
 - Parallel connection of other actuators possible.
- Note the performance data.

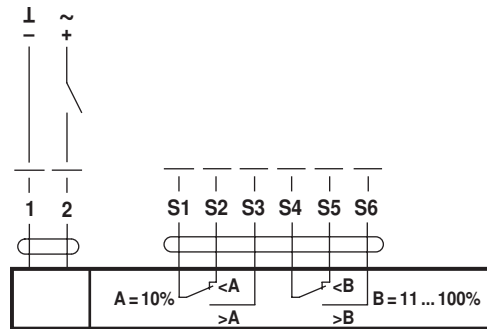

Cable colours:

- 1 = black
- 2 = red
- S1 = violet
- S2 = red
- S3 = white
- S4 = orange
- S5 = pink
- S6 = grey

Dimensions [mm]

Dimensional drawings

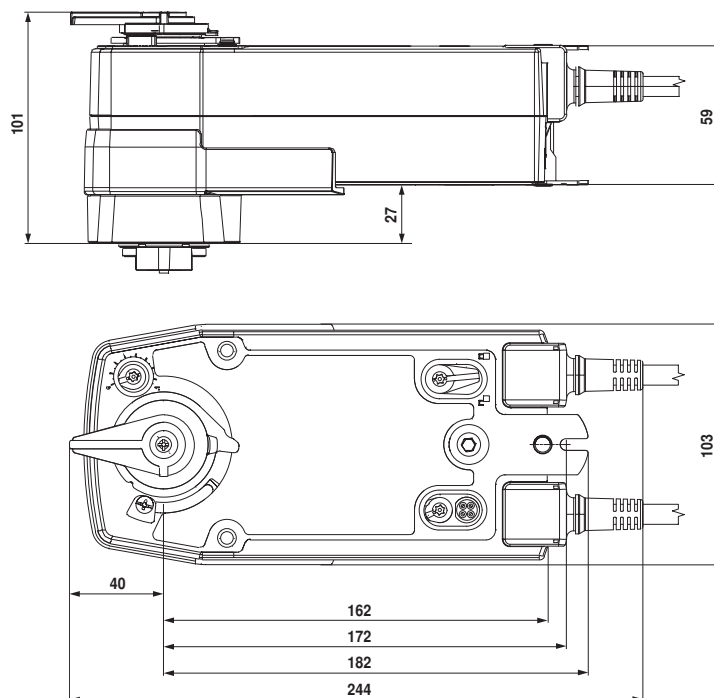

Further documentations

- Complete overview «The complete range of water solutions»
- Data sheets for ball valves
- Installation instructions for actuators and/or ball valves
- Notes for project planning (hydraulic characteristic curves and circuits, installation regulations, commissioning, maintenance etc.)

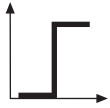

AC 24 V / DC 24 V

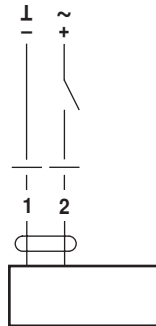

NRF24A(-O)
SRF24A(-O)

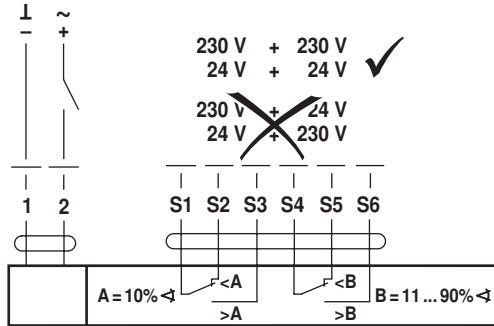

NRF24A-S2(-O)
SRF24A-S2(-O)

230 V + 230 V
24 V + 24 V ✓
~~230 V + 24 V~~
~~24 V + 230 V~~

AC 100 ... 240 V ⚠

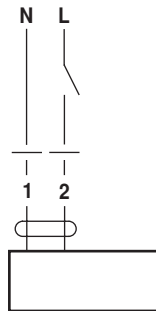

NRF230A(-O)
SRF230A(-O)

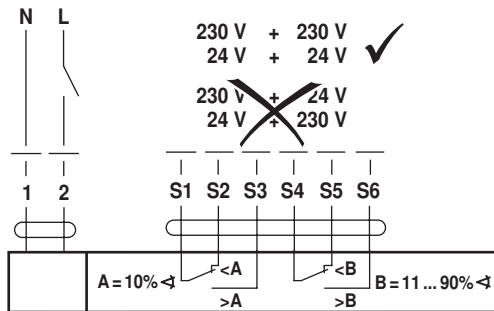

NRF230A-S2(-O)
SRF230A-S2(-O)

230 V + 230 V
24 V + 24 V ✓
~~230 V + 24 V~~
~~24 V + 230 V~~

AC 24 ... 240 V / DC 24 ... 125 V ⚠

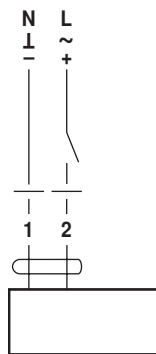

NRFA(-O)
SRFA(-O)

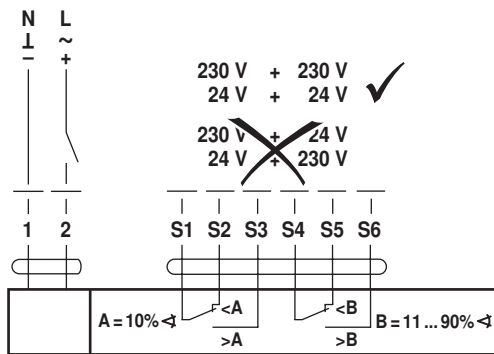

NRFA-S2(-O)
SRFA-S2(-O)

230 V + 230 V
24 V + 24 V ✓
~~230 V + 24 V~~
~~24 V + 230 V~~

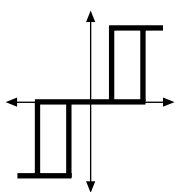

AC 100 ... 240 V ⚠

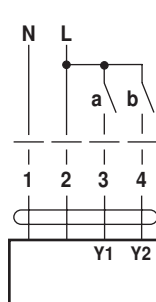

NRF(D)230A-3(-O)
SRF230A-3(-O)

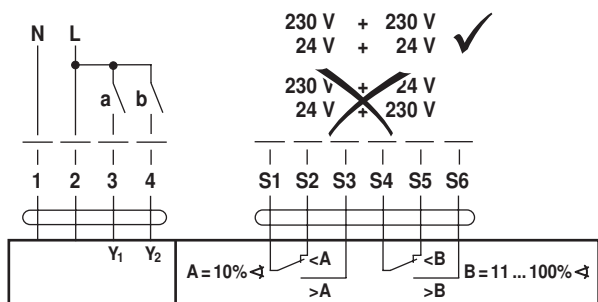

NRF(D)230A-3-S2(-O)
SRF230A-3-S2(-O)

230 V + 230 V
24 V + 24 V ✓
~~230 V + 24 V~~
~~24 V + 230 V~~

		NO	NC	
a (Y1)	b (Y2)			
				A - AB = 100%
		stop	stop	
				A - AB = 0%