

Diverter motor driven valve of
EMV 110 F3L series

FIRST®

ROTODIVERT F3L



GENERAL:

Electric motor driven EMV110 actuator with installed 3-way brass valve operate as diverting or separating element in closed systems of remote (warm water), air blast or combined heating systems using either of the sources, remote or air blast heating.

FEATURES:

- Compact version enables quick assembly and electrical connection.
- Actuator is simply and quickly assembled and disassembled from reversible valve by means of "clip-clap" system, no screwing is required.
- Effectively and economically used as reversible element in systems where two heating sources are used or for supply of heating to two consumers - heating and sanitary water.
- Dimensions of reversible valve from 1" to 1 1/4" are suitable for systems with copper pipes
- Two-wire control with thermostat and other devices
- Connecting cord enables external connection.
- Built-in relay enables SPST and SPDT connection.
- Quick replacement of O-rings without disassembling the valve from installation.

FASTENING AND REMOVING THE ACTUATOR ON/FROM REVERSIBLE VALVE

The actuator push perpendicular to valve so that it seats on carrying holders. The mounting is finished. If you need to remove the actuator from the valve simply pull it out.

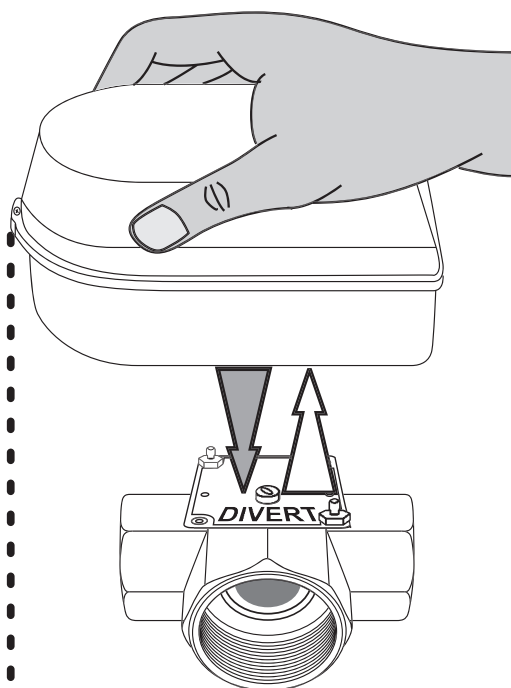

M4 screw is inserted at the bottom of the actuator and prevents removal of the actuator from the valve by unauthorised person

Possibility of sealing the actuator to prevent unauthorised person to interfere with it.

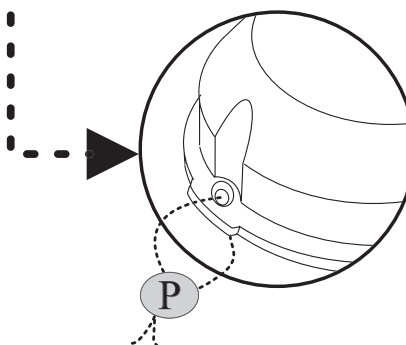

! ATTENTION !

Before an intervention inside the actuator, disconnect power supply.

SERIES F3L

DIVERTING BRASS VALVE WITH ELECTRIC MOTOR DRIVEN ACTUATOR

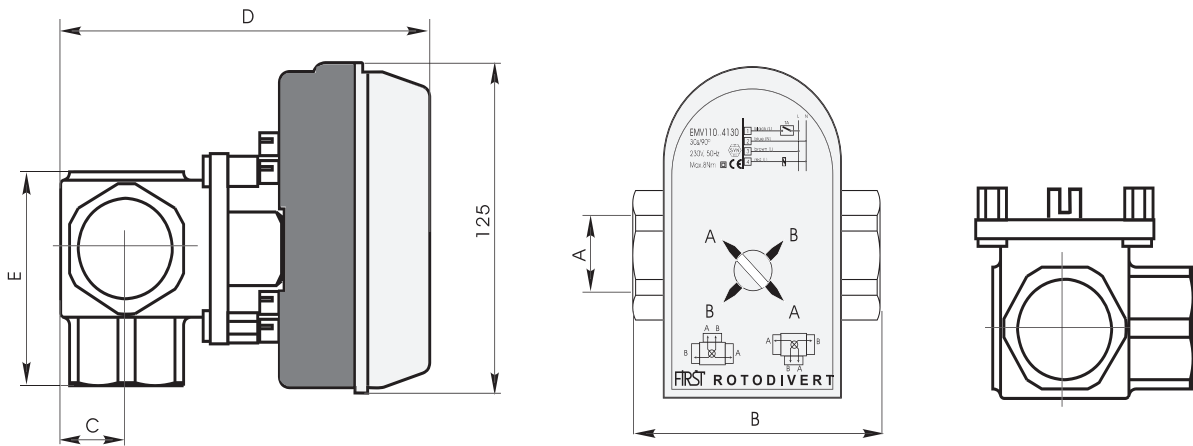

CODE	TYPE	DN	A	B	C	D	E	Kvs	kg
10170	EMV ROTODIVERT F3L	15	1/2"	72	18,5	116	54	4	1,1
10171	EMV ROTODIVERT F3L	20	3/4"	72	18,5	116	54	7	1,0
10172	EMV ROTODIVERT F3L	25	1"	90	24	122	69	8,5	1,12
10173	EMV ROTODIVERT F3L	32	1 1/4"	90	24	122	69	12	1,37

TECHNICAL CHARACTERISTICS

EMV110 F3L actuator

Supply voltage 230V, 50Hz (EMV 110..4680)
 * 24V, 50Hz (EMV 110..4683)
 Limit switch 5(1)A, 250V, 50Hz
 Consumption 7.5VA during operation
 3VA during standstill
 Electrical connection class II acc. to EN60355-1
 Actuator protection class IP44 acc. to IEC 529
 Rotation time 18s/90°
 Output torque max 8Nm
 Ambient temperature from 0° C do 50°C
 Connecting cord 4 x 0.5 mm², 2m long

Forged brass valve:

Max. operating temperature 110°C
 Max. operating pressure 6 bar
 Torque 0.5 Nm

Special versions:

Reversion time 30s/90°
 Max. output torque 10 Nm
 Other data are the same.

Kvs for valves F3L DIVERT type

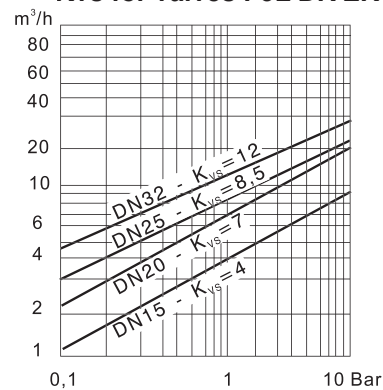

Characteristic of flow

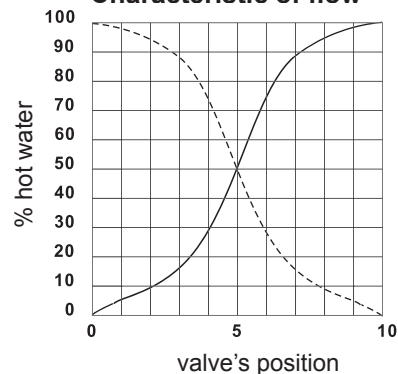

MANUAL SETTING OF FLAP POSITION

Flap position is set with a screwdriver, coin or the like.
 First check proper adjustment of the flap and then mount the actuator.

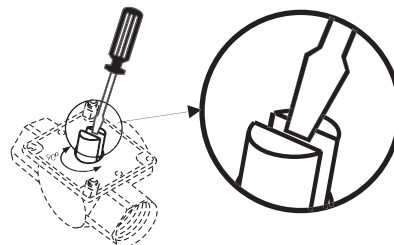

EXAMPLES OF USE

EXAMPLE 1

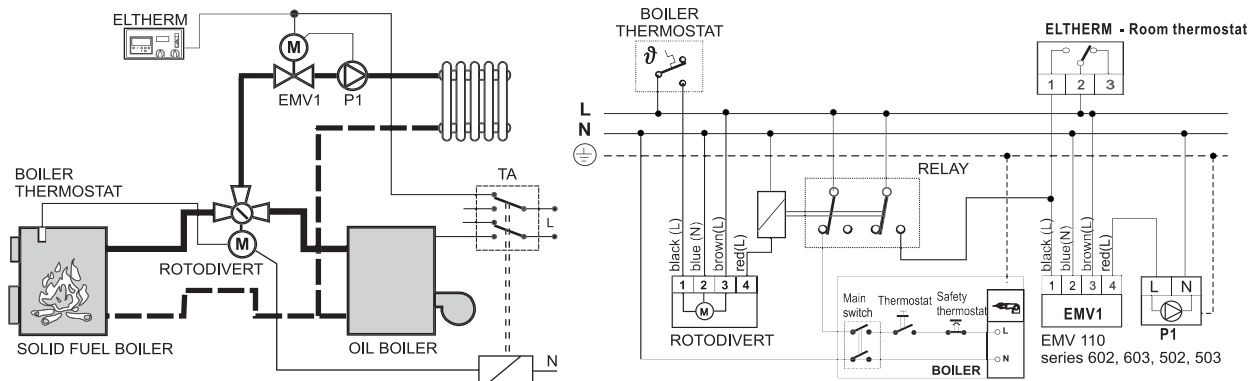

Divterter valve switches between two heating sources. This combination ensures utilisation of cheaper energy source. When this source is consumed, reversible valve switches to the second energy source and with limit switches, which are in the actuator, activates the second energy source. The flow through the pump is never completely closed by F3L reversible valve, therefore no pressure shocks appear.

EXAMPLE 2

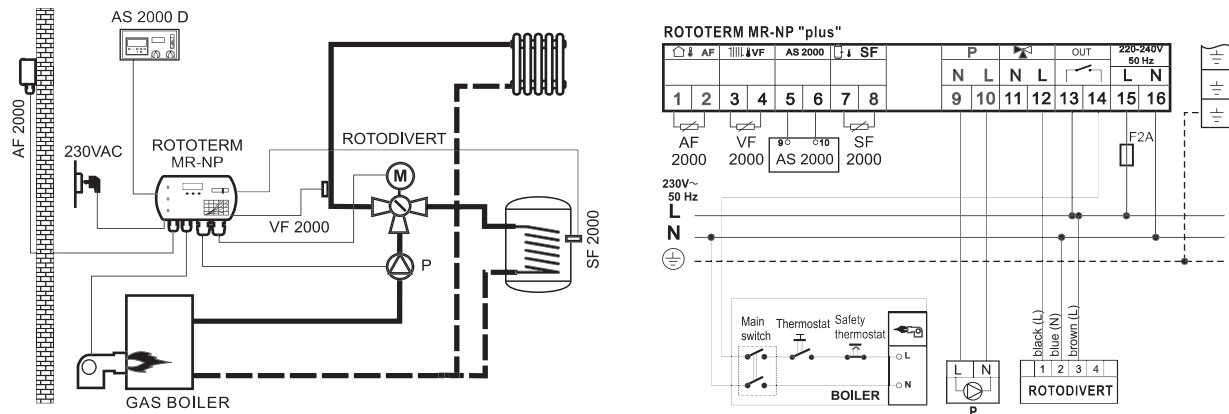

In combination with " ROTOTERM MR-NP" automatic control system of the house this separating valve enables heating of a residential unit and sanitary water with just one pump, where sanitary water has priority. The flow through the pump is never completely closed by ROTODIVERT diverter valve, therefore no pressure shocks appear.

EXAMPLE 3

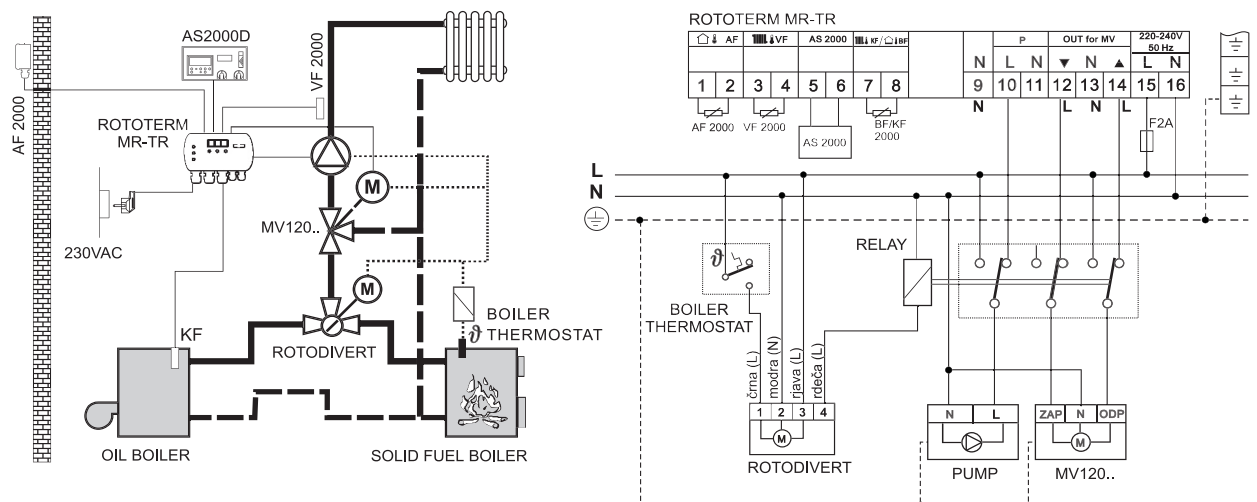

Divterter valve switches between two heating sources. This combination ensures utilisation of cheaper energy source. When this source is consumed, reversible valve switches to the second energy source and with limit switches, which are in the actuator, activates the second energy source. For heating regulation is used regulator ROTOTERM MR-TR.

IMPORTANT!

The safety valve must be installed in case of overheating of solid fuel boiler. Up two examples are only for showing the basic installation.

To extend the long term performance of the motorised ball valve it is recommended that a strainer is situated prior to the valve. By installation must be observed to according to relevant local standards.

ELECTRICAL CONNECTION

Two wire SPST control

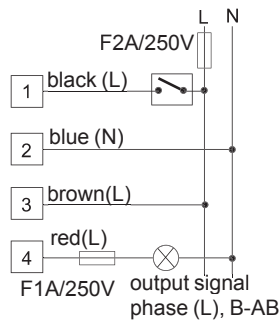

Three wire SPDT control

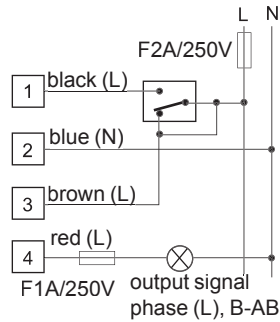

special version: EMV 110..4680-S1

(built in non voltage output switch for controlling burners, ...)

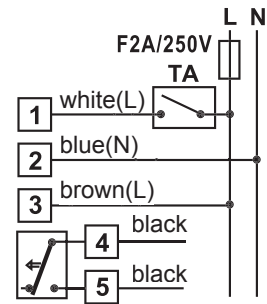

WARNING

When making electrical connection, an element which enables at least 3mm separation from the mains (switch or socket) must be installed between conductor of electric motor driven actuator and power supply. In case of an intervention inside the actuator, disconnect the device must from power supply.

SPECIAL VERSIONS

Outer thread on all three connections (A, B, AB)

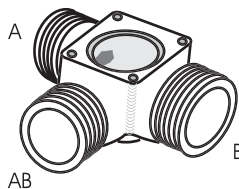

Outer and inner thread on all three connections (A, B, AB)

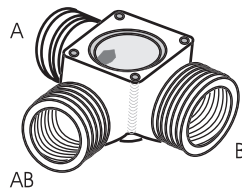

WITH INSIDE SMOOTH HOLE (AB) WITH O-RINGS AND GROOVE FOR USE

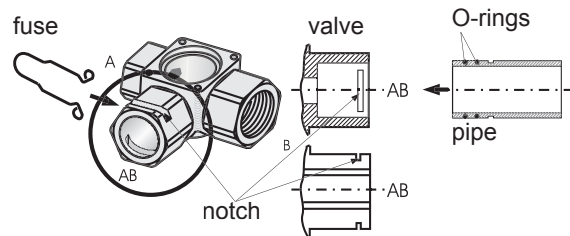

VALVE'S PARTS

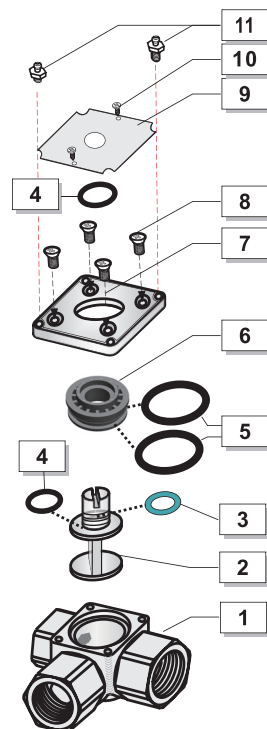

POS	NAME	PCS	MATERIAL
1	Body	1	Hot stamped CuZn39Pb3
2	Flap stem	1	Brass CuZn39Pb3
3	O-ring 8.73x1.78	1	Viton FKM
4	O-ring 11.91x2.62	2	EPDM
5	O-ring 23.3.5x2.4	2	EPDM
6	Insert	1	RYTON R-4-200 BL
7	Valves top	1	alloy
8	Screw M5x10	4	
9	Position plate	1	Al
10	Screw 2.9x6.5	2	
11	Distance bolts	2	

*enclosed with actuator

Reserve O-ring
(position 4)
code: 500032

By installation must be observed to
according to relevant local standards.
The installation must be grounded!

We reserve the right to modify the instructions and the technical data of the product without prior notice

FIRST®

FIRŠT-ROTOTEHNIKA, s.p.,
Radegunda 54, 3330 Mozirje
tel: ++386 3 898 35 00, fax: ++386 3 898 35 35
e-mail: info@first.si, http://www.first.si